



Waterworks

BERMAD Meters

Merging monitoring & control



DC Powered Composite Electromagnetic flowmeter

MUT7000



MUT7000 Sensor

MUT7000 is an electromagnetic flow meter grooved sensor that covers all diameters from DN50 to DN150. When high accuracy, light weight, and compact dimensions are required, the choice of sensors cannot be other than MUT7000.

These performances allow to measure low flow rates precisely and repeatable, even in difficult/ problematic applications with solid parts.

The MUT7000 sensor series bases its operation on the Faraday Principle, by which a conductor crossing a magnetic field generates an electrical potential perpendicular to the field itself. On the top and on the lower side of the composite flow tube, two coils are installed; the magnetic field generated by the electric current crossing the coils, induces in the electrodes a potential difference proportional to the flow rate.

The integrated battery powered converter generates the current supplying the coils, acquires the electrodes potential difference, process the signal to calculate the flow rate and manages all the communications. The entire sensor has an IP68 protection degree suitable for a permanent immersion in water up to a depth of 1.5m.

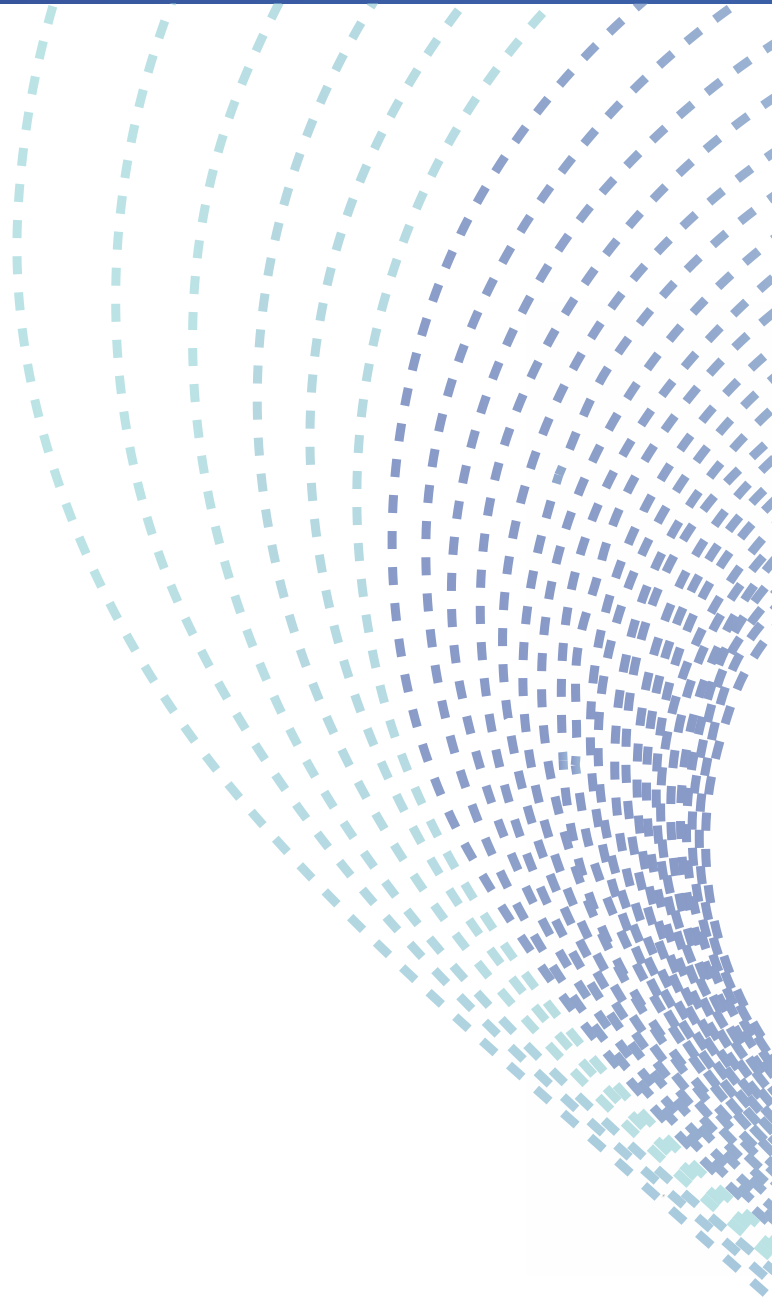



— The electromagnetic flowmeter designed for the toughest applications —



Bluetooth™

Modbus

DS401-1-ENG



Body and flanges

The MUT7000 have a flow tube made from composite material. It is equipped with an integrated converter. The degree of protection is IP68. It may be installed between flanges up to PN 16 or ANSI 150. The sensor is grooved and can easily fit to all type of end connections with the preferred adaptor.

Internal lining

The sensor body is in composite, thus the temperature of the liquid to be measured has to be between 0°C and + 80°C.

Electrodes and grounding

The MUT7000 has three electrodes in AISI 316L and, on request, they can be supplied in other materials. It should be noted that if the sensor is installed in metal pipe line, the liquid grounding does not require the use of grounding rings, because of the presence of the third electrode.

A revolutionary perspective of the flowmetering

The MUT7000 is a battery powered and 12Vdc electromagnetic water meter for use in district metering areas (DMA), water abstraction, and custody transfer measurement of potable water (MI-001, OIML R49), irrigation, and many other applications.

Unlike other water meters, the MUT7000 is a maintenance-free meter, offering a much wider range of flow, in a compact version. Thanks to the optimized flow profile, the MUT7000 can be installed virtually anywhere without straight inlet or outlet runs, behind



pipe bends, slide valves or a reduction in the pipe. Its measuring tube is in fact specifically designed to enable a stable measurement even at the lowest flow rates.

Made out of highly reinforced polyamide, the meter is the perfect solution for leak detection, and pressure management systems. The highly robust and at same time lightweight structure, allows IP68 installations with accordance to the manufacturer's guidelines.

Victualic OGS process connections make the flow meter compatible with almost all installations, adapting flanges of all type and standards are also available. Easy and quick to install, users will find this flow meter the perfect solution compared not only to mechanical meters, but to any other non-moving parts flowmeters.

The inbuilt logger functionality provides total flexibility - enabling data to be interrogated in precise detail through the smart and user friendly Mag-Net app, available on Apple and Google play store.

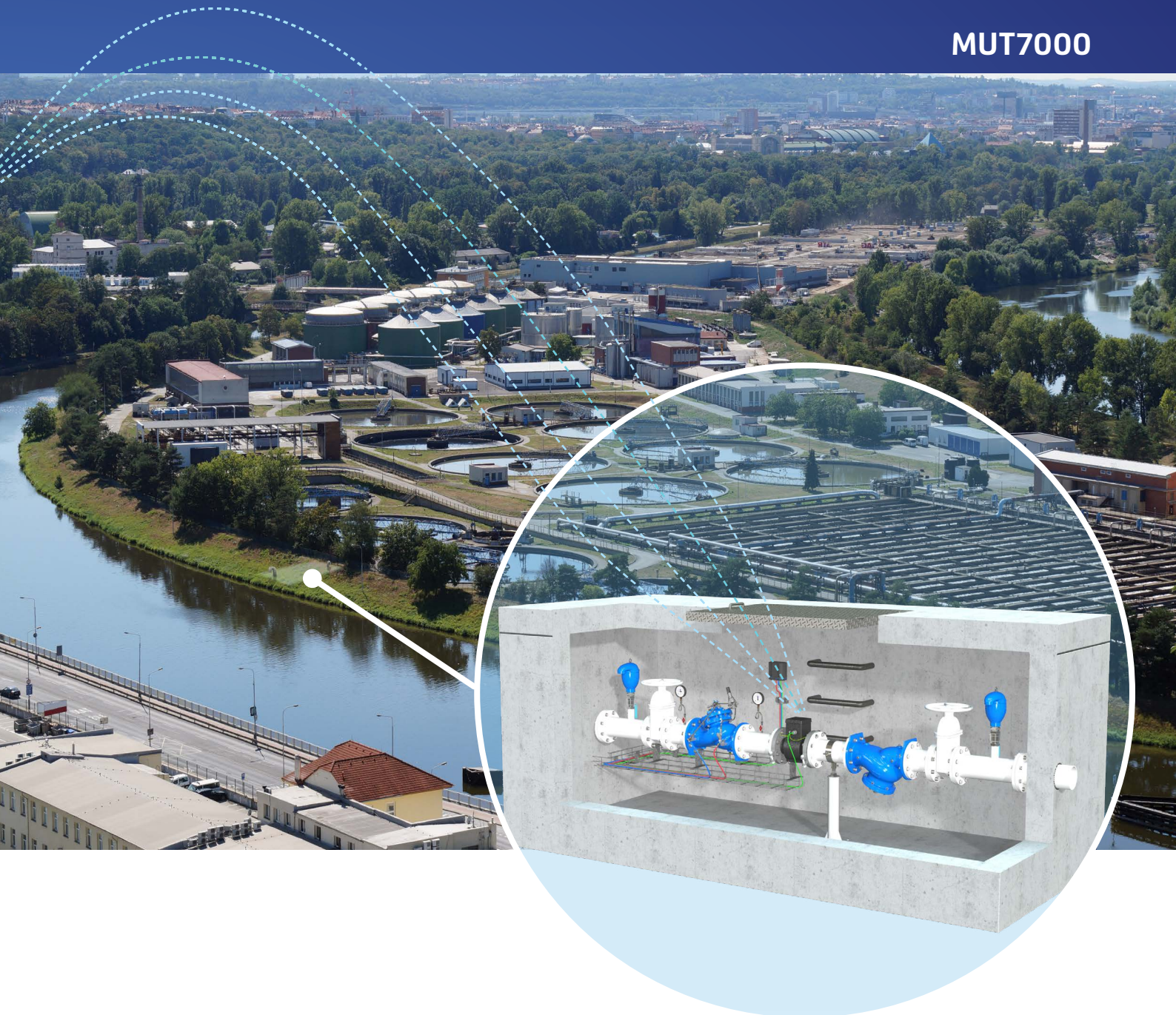

Installation with no upstream and downstream distances

The MUT7000 internal part of the sensor, allows an optimized and accelerated flow profile which permits to install the sensor in any kind of condition; no need to have straight sections/segments of pipes upstream and downstream. This U0-D0 condition enables to have an extreme flexibility on the flow meter installation position.

Standards reference

The MUT7000 electromagnetic meters are marked CE and are manufactured according to the following standards:

- 2014/53/EU
- 2014/30/EU - EN 61326-1:2013 (EMC)
- 2014/65/EU
- EN IEC 60529
- OIML R49-1:2013
- European directive 2014/32/EU (MID)

Applications

- District metering of potable water
- Distribution, municipal water
- Overnight applications with very low flow rate
- Installation in small places without straight distances
- Leak detection and monitoring
- Fiscal measures, custody transfer
- Irrigation

Advantages

- No moving parts
- Grooved connection - fits all applications
- Long lasting stability and precision, no filter needed, zero maintenance
- Lightweight sturdy structure
- Accurate measure at high flow rate and at low flow rates
- Bi-directional measure
- Internal parts protected by a bi-component resin in order to increase protection from external agents
- Wider range of measurement

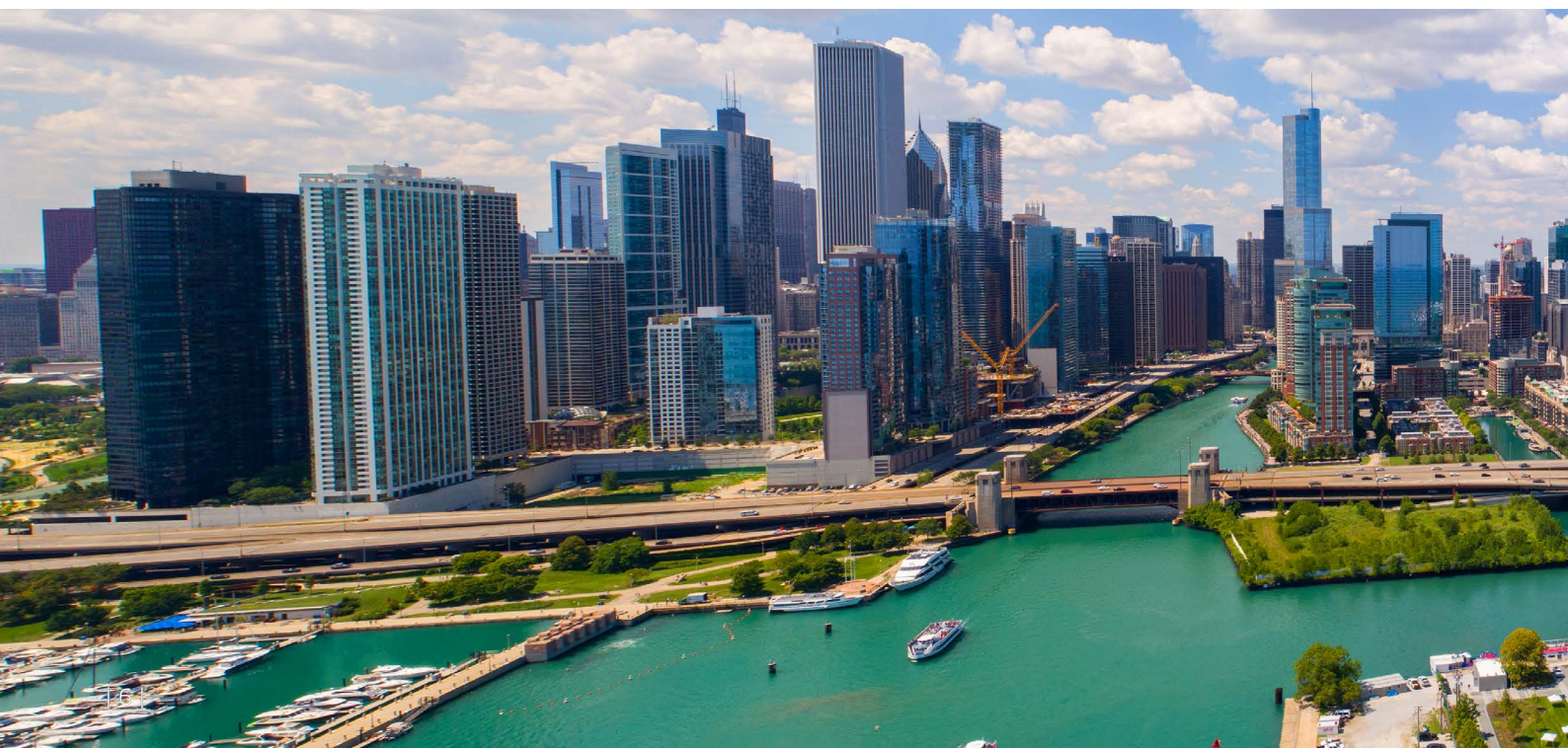

Technical features MUT7000

FEATURES	MUT7000
Structure	Integral Flow meter
DN Range	DN50/2" ÷ DN150/6"
Nominal Pressure	16 bar
Process Connection	Victaulic OGS
Fluid Conductivity	> 20 µS/cm
Process Temperature Range	0 ÷ 80 °C (32 ÷ 176 °F)
Materials in contact with water	Flow tube: Glass fibre reinforced plastic Electrodes: AISI316L
Power supply	Battery Powered: 3.6 V Lithium Battery Mains Powered: 12Vdc (10.8 ÷ 13.2V), max 100mA
Consumption	0,25W±1W (Mains powered)
Outputs	2 passive outputs (1 programmable), SSR Type (dry contact), galvanically insulated Max. load +/- 35VDC, 100 mA protected against short circuits, minimum pulse duration 5ms. RS458 2 wire /half-duplex
Communication	Modbus RTU Slave Bluetooth
Display	LCD Segment display, with dedicated status icons, 8+6 digits
User Interfaces	Magnetic reed Bluetooth Mobile App Euromag Link Software
Process memory	100,000 data lines Programmable frequency 1 ÷ 120 minutes (15 minutes factory standard)
Metrological certificate	OIML R49-1:2013 / MID 2014/32/EU - Class 2 (if requested)
Temperature range	Ambient: -20 ÷ 60 °C (-4 ÷ +140 °F) Process: 0 ÷ 80 °C (32 ÷ 176 °F) Storage: -40 ÷ 70 °C (-40 ÷ +158 °F)
Technical units	m, m3, l, ML, ft3, gal
Totalizers	5 (2 Positive, 2 Negative, 1 Net)
Alarms and status icons	Status icons displayed and alarms recorded in the data logger
Self diagnostic	Excitation failure Excessive ambient temperature Wet electronic board Low battery level / Mains voltage out of range Pulses overlapping Bluetooth communication error Empty pipe Measurement error Software/memory malfunction Mains power interruption
Software for communication and programming	Bluetooth Mobile App - Mag-Net Euromag Link Software (through Bluetooth dongle, or RS485 interface)
Data Protection	Customizable password protection EEPROM Memory with safe data storage management



Calibration and maximum error

Each sensor is calibrated on an hydraulic test rig equipped with a ISO17025 traceable weighing system. The accuracy is equal to 0.2% ± 2mm/s. The repeatability of the measure is about 0.1%. Bi-directional measure. On request the MUT7000 can be supplied certified MID OIML R49 for custody transfer.

Flow rates chart

Sensor diameter	Ø In and Outlet (mm)	Flow [m³/h]				Ratio Q3/Q1
		Min Q1	Trans. Q2	Perm. Q3	Overl. Q4	
DN50 - 2"	50	0.10	0.16	40	50	400
DN80 - 3"	80	0.25	0.40	100	125	400
DN100 - 4"	100	0.40	0.64	160	200	400
DN150 - 6"	150	1.00	1.60	400	500	400

Maximum Permissible Error is within the limits indicated in the following graph:

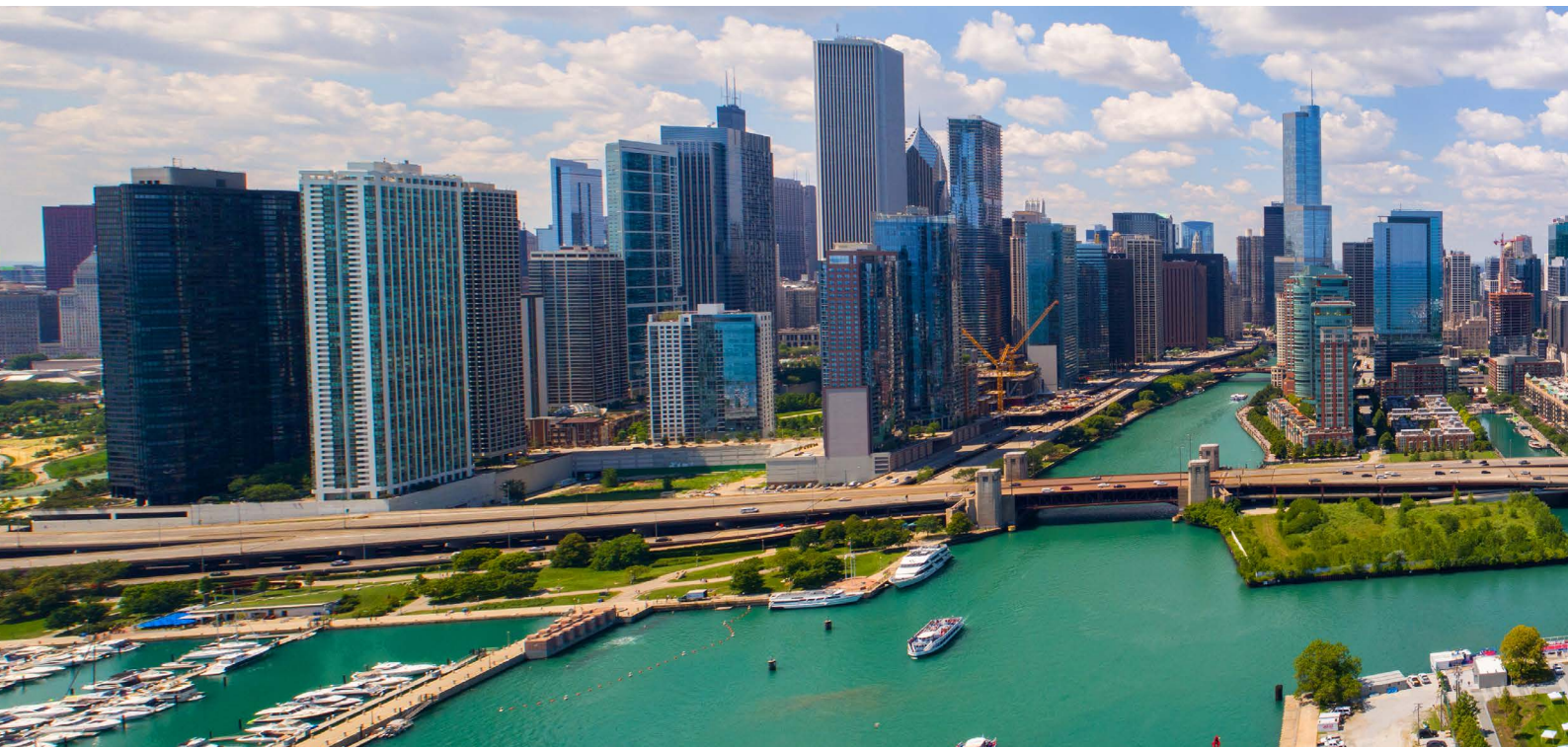
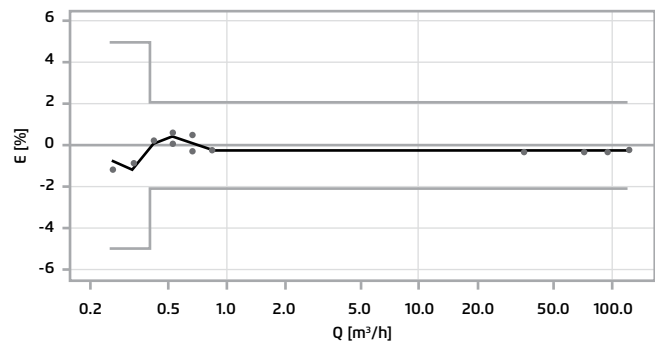

Overall Dimensions

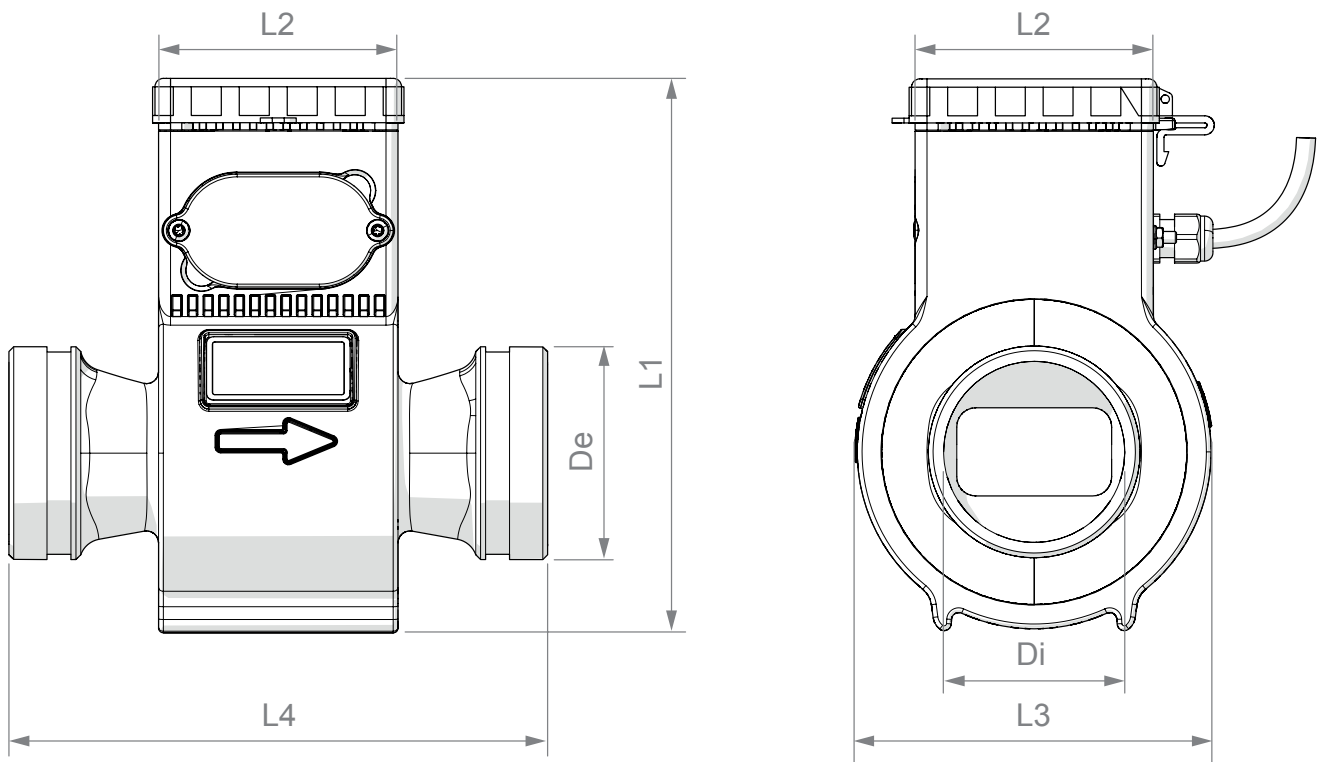

Size	De	L1	L2	L3	L4
DN50 - 2"	60.3	230	100	150	200
DN80 - 3"	88.6	230	100	150	225
DN100 - 4"	114.3	230	100	150	250
DN150 - 6"	168.3	300	100	210	300



Easy and intuitive interface

Everything you need from flowmeter with a blink of an App.

In a fast developing and interconnected world, data must be available and exchanged anytime, anywhere. Mag-Net app is the BERMAD solution.

Reliable

Ultra low power bluetooth communication

Contactless

A contactless interface allows users to interact with the transmitter up to a range of more than 10m. from the comfort of your car.

Chart and retrieve data

The Mag-Net app allow users to view the log file on their smart phone/tablet and download it as CSV file.

Infinite possibilities

Consult, analyse, monitor, the data directly with your touch through simple gestures

Easy and intuitive

The Mag-Net app is easy and intuitive to use, allowing users to deal with the instrumentation.

Smart configuration

Users can easily configure or modify settings of their flow meters using Mag-Net app.

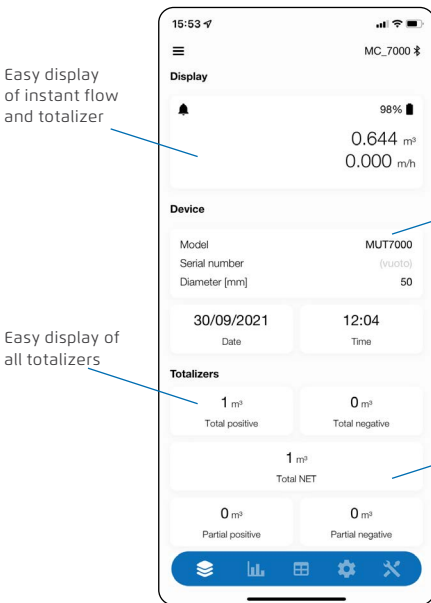

Easy display of instant flow and totalizer

Quick view of model and serial number

Easy display of all totalizers

Partial totalizers, quick reset

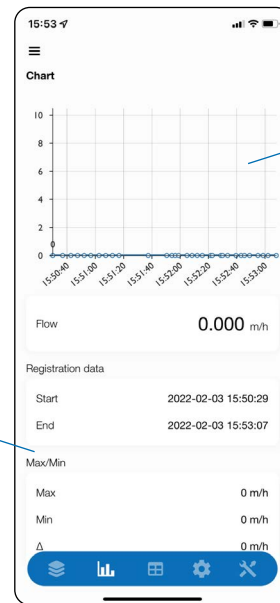

View the instantaneous flow in the intuitive graph

Immediate view of Max, Min flowrate of the system



Features

Long-lasting performance

Battery powered up to 10 years or 12vdc.

U0-D0

Zero upstream and downstream distances (MID-001 OIML R49 certified).

All-in-one

Electronic converter integrated in the sensor body, compact and lightweight for easy use.

Highly-resistant

Reinforced polyamide with Victaulc OGS process connections.

Empty pipe detection

Empty pipe detection on measuring electrodes.

Easy management, easy programming

Mag-Net app available on App Store and Google Play.

Data logging

Data automatically stored in the internal Eeprom memory. Up to 100,000 lines of active data-logging.

Certifications and compliance

OIML R49 MID-001 / WARS* / NSF ANSI61*

* pending

About BERMAD

BERMAD is a leading, privately-owned global company that designs, develops and manufactures tailor-made water & flow management solutions that include state-of-the-art hydraulic control valves, air valves and advanced metering solutions.

Founded in 1965, we have spent over 50 years interacting with the world's major end users,

and accumulating knowledge and experience in multiple markets and industries. Today, we are recognized as a pioneer and established world-leading provider of water & flow management solutions that give our customers the unprecedented operational efficiency, and superior quality, durability and performance they need to meet the demanding challenges of the 21st century.

1 ozbranding.co.il |

