

Electro-Pneumatically Controlled Deluge Valve with EasyLock™ Manual Reset

Model: FP 400E-3M

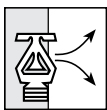

Typical Applications



Automatic spray or foam systems



Offshore platforms

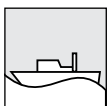

Marine environments



Sea water / corrosive water supplies

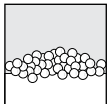

Foam fire systems

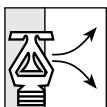

Increased reliable response by dry solenoid



Dual redundant detection systems

Features and Benefits

- **Dry solenoid** – Suitable for corrosive water or foam
- **Latch open** – Closes upon local reset only
- **One-piece molded elastomeric moving part** – No maintenance required
- **Simple design** – Cost effective
- **Obstacle-free full bore** – Uncompromising reliability
- **Factory pre-assembled trim** – Out of-box quality
- **In-line serviceable** – Minimal down time

Optional Features

- **Water motor alarm**
- **Alarm pressure-switch** (code: P or P7)
- **Explosion-proof** for hazardous locations (code: 7/8/9)
- **Seawater service** (add FS as prefix to model)
- **Valve Position Single/Double Limit Switches**

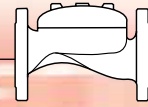

Operation

The BERMAD Model FP 400E-3M is suitable for systems that include electric fire detection and a piping system with a wide variety of open nozzles. Being electro-pneumatically controlled, the Model FP 400E-3M is recommended in cases, such as seawater installations, where it is advantageous to keep the solenoid [1] dry.

In the SET position, the line-pressure supplied to the main valve's control chamber [2] via the priming line [3] and through an EasyLock Manual Reset, [4] is trapped by the EasyLock internal check valve, by a closed Pneumatic Pressure Operated Relief Valve (PORV) [5], and a closed Manual Emergency Release [6]. The trapped pressure holds the main valve's diaphragm and plug against the valve seat [7], sealing it drip-tight and keeping the system piping dry. The PORV is held closed by the maintained pneumatic pressure, supplied through the Solenoid [1].

Under FIRE or TEST conditions, an electric detection system [E], through a control panel [C], triggers the Solenoid to release the trapped pneumatic pressure from the PORV, thereby opening it. Pressure is then released from the control chamber through the opened PORV, or the Manual Emergency Release. The EasyLock prevents line-pressure from entering the control chamber, allowing the main valve to latch open and water to flow into the system piping and to the alarm device.

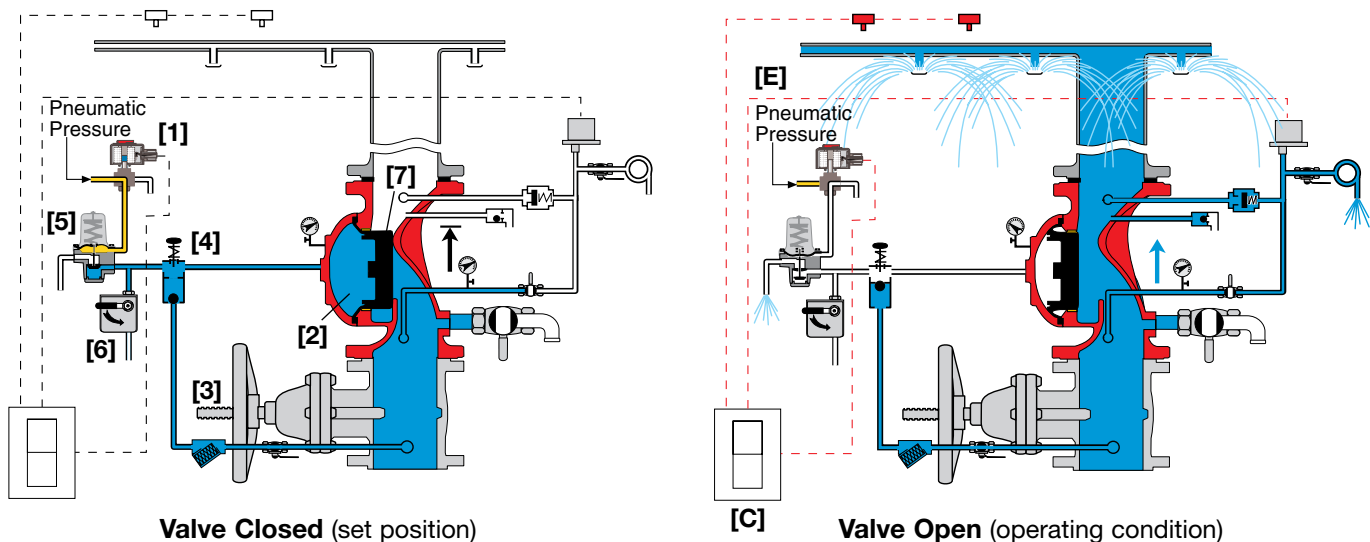

Engineer Specifications

- The deluge valve shall be a UL-Listed, electro-pneumatically controlled elastomeric type globe valve with a **rolling-diaphragm**.
- The valve shall have an **unobstructed flow path**, with no stem guide or **supporting ribs**.
- Valve actuation shall be accomplished by a fully peripherally supported, one-piece balanced rolling-diaphragm, vulcanized with a rugged radial seal disk. The diaphragm assembly shall be the only moving part.
- The valve shall have a removable cover for quick in-line service enabling all necessary inspection and servicing.
- The control trim materials shall consist of S.S.316 tubing and fittings, and plated brass accessories, including local **EasyLock** Manual Reset, PORV pneumatic pilot valve, 3-way Solenoid valve, Y strainer and Manual Emergency Release.
- The control trim shall be supplied as an assembly, pre-assembled and hydraulically tested at an ISO 9000 and 9001 certified factory.
- The electro-pneumatic deluge valve shall latch open in response to an electric signal. The valve shall reset to the closed position only upon local activation of the manual reset device.

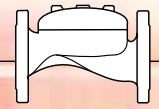



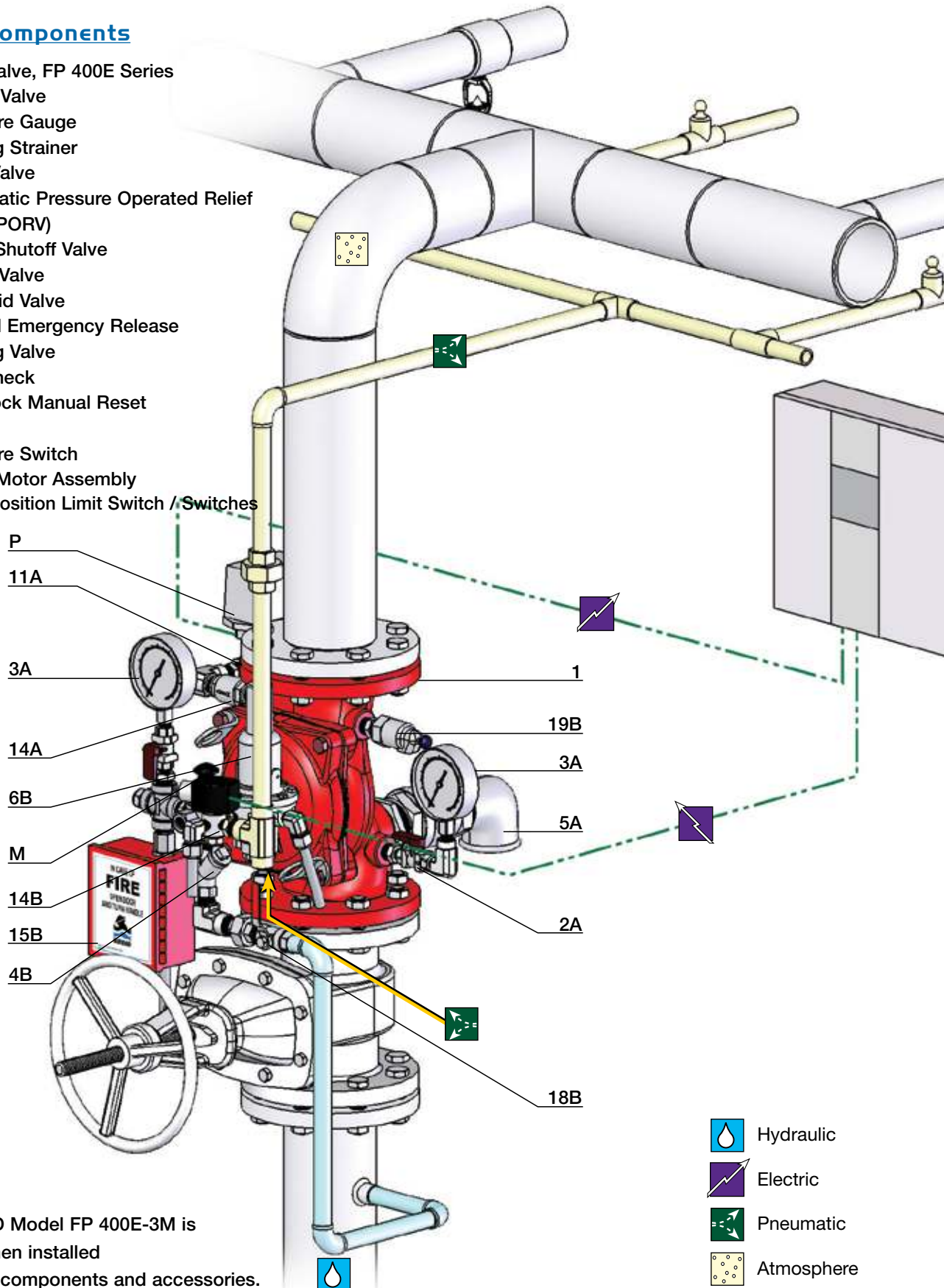

System Components

- 1 - Main Valve, FP 400E Series
 - 2A - Gauge Valve
 - 3A - Pressure Gauge
 - 4B - Priming Strainer
 - 5A - Drain Valve
 - 6B - Pneumatic Pressure Operated Relief Valve (PORV)
 - 11A - Alarm Shutoff Valve
 - 14A - Check Valve
 - 14B - Solenoid Valve
 - 15B - Manual Emergency Release
 - 18B - Priming Valve
 - 19B - Drip Check
 - M - EasyLock Manual Reset
- Optional**
- P - Pressure Switch
 - W - Water Motor Assembly
 - S - Valve Position Limit Switch / Switches



UL Listed

The BERMAD Model FP 400E-3M is UL-Listed when installed with specific components and accessories.

-  Hydraulic
-  Electric
-  Pneumatic
-  Atmosphere

BERMAD Fire Protection

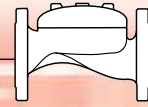

Model: FP 400E-3M

400 Series

Technical Data

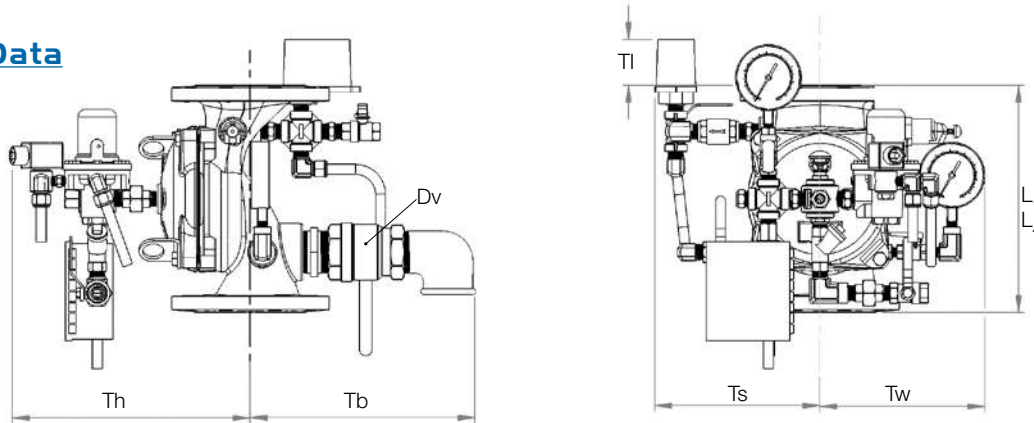

Size	1½", 2"		2½"		3"		4"		6"		8"		10"		12"		
	mm	inch	mm	inch	mm	inch	mm	inch	mm	inch	mm	inch	mm	inch	mm	inch	
Dimensions	L ₁ ⁽¹⁾	205	8 1/16	205	8 1/16	257	10 1/8	320	12 5/8	415	16 5/16	500	19 11/16	605	23 13/16	725	28 9/16
	L ₂ ⁽²⁾	205	8 1/16	N/A	N/A	250	9 13/16	320	12 5/8	415	16 5/16	500	19 11/16	N/A	N/A	N/A	N/A
	TI	142	5 5/8	142	5 5/8	119	4 11/16	84	3 5/16	57	2 1/4	-	-	-	-	-	-
	Tw	228	9	220	8 11/16	243	9 9/16	253	10	312	12 5/16	326	12 13/16	346	13 5/8	391	15 3/8
	Ts	228	9	220	8 11/16	243	9 9/16	253	10	318	12 1/2	326	12 13/16	326	12 13/16	391	15 3/8
	Th	226	8 7/8	242	9 1/2	262	10 5/16	261	10 5/16	356	14	407	16	407	16	546	21 1/2
	Tb	278	10 1/16	289	11 3/8	300	11 13/16	337	13 1/4	378	14 7/8	405	15 15/16	413	16 1/4	473	18 5/8
	Dv Ø	¾"		1 ½"		1 ½"		2"		2"		2"		2"		2"	

- Notes:**
- L₁ is for flanged ANSI #150 and ISO PN16.
 - L₂ is for grooved end connections (Ductile Iron Only).
 - Provide adequate space around valve for maintenance.
 - Data is for envelope dimensions, specific component positioning may vary.

Connection Standard

- Flanged: ANSI B16.42 (Ductile Iron), B16.5 (Steel & Stainless Steel), B16.24 (Bronze) or ISO PN16
- Grooved: ANSI/AWWA C606 for 2, 3, 4, 6 & 8"

Water Temperature

- 0.5 – 50°C (33 – 122°F)

Manufacturers Standard Materials

Main valve body and cover

- Ductile Iron ASTM A-536

Main valve internals

- Stainless Steel 304 & Cast Iron

Control Trim System

- Brass control components/accessories
- Stainless Steel 316 tubing & fittings

Elastomers

- Nylon fabric reinforced polyisoprene NR

Coating

- Electrostatic Powder Coating Polyester, Red (RAL 3002)

Available Sizes

- 1½, 2, 2½, 3, 4, 6, 8, 10 & 12"
- UL-Listed for sizes 1½, 2, 2½, 3, 4, 6, 8 & 10"

Pressure Rating

- Max. working pressure: 250 psi (17 bar)

Optional Materials

Main valve body

- Carbon Steel ASTM A-216 WCB
- Stainless Steel 316
- Ni-Al-Bronze ASTM B-148

Control Trim

- Stainless Steel 316
- Monel® and Ni-Al-Bronze
- Hastalloy C-276

Elastomers

- NBR
- EPDM

Coating

- High Built Epoxy Fusion-Bonded with UV Protection, Anti-Corrosion

PORV Setting

Valve opens on pilot line pressure drop
factory set: 20 psi (1.5 bar)

Solenoid Pilot Valves

Standard

- 3-Way, direct actuated type
- Brass body
- Main valve closed when de-energized
- Enclosure: General purpose watertight, NEMA 4 and 4X / IP65, Class F
- Power: 24VDC, 8 watts
- UL – Listed

Options (see also ordering guide)

- Hazardous locations:
 - Class I Division 1, Gr. A, B, C, D, T4 (code 7)
 - Class I Division 2, Gr. A, B, C, D, T4
 - ATEX, EEx d IIC T5 (code 9)
- Voltage: see ordering guide (voltage options)
- Stainless Steel 316 body material (code K)



bermadfire@bermad.com • www.bermad.com

The information herein is subject to change without notice. BERMAD shall not be held liable for any errors. All rights reserved. © Copyright by BERMAD. PE4PE-3M 04