

Electro-Pneumatic Pressure Control, On-Off Deluge Valve

Model: FP 400E-6DC



UL LISTED

Typical Applications



Fluctuating or over pressure



Offshore platforms



Marine environments



Seawater/corrosive water supplies



Foam fire systems



Increased reliable response by dry solenoid



Redundant safety detection systems

Features and Benefits

- **Pressure control function** – Constant lower preset, downstream pressure
- **Remote reset** – Shut-off on remote command
- **One-piece molded diaphragm-Only moving part** – No maintenance required
- **Dry solenoid** – Suitable for corrosive water or foam
- **Simple design** – Cost effective
- **Obstacle-free full bore** – Uncompromising reliability
- **Factory pre-assembled trim** – Out-of-box quality
- **In-line serviceable** – Minimal down time

Optional Features

- **Alarm pressure-switch** (code: P or P7)
- **Explosion-proof** for hazardous locations (code: 7/8/9)
- **Fail-safe open** (energized to close main valve)
- **Seawater service** (add FS as prefix to model)

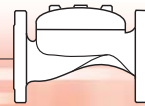

Operation

BERMAD's Model FP 400E-6DC is suitable for systems that include redundant safety (electric and pneumatic) fire detection and piping systems with a wide variety of open nozzles. Since it is pneumatically controlled, the Model FP 400E-6DC is recommended where it is advantageous to keep the solenoid [1] dry, such as seawater installations. Combining a pressure reducing feature, it is also suitable for systems with high pressure supply source and/or relatively low flow.

In the SET position, the line-pressure supplied to the main valve's control chamber [2] via the priming line [3], through a Check Valve [4], and an Accelerator [5] with priming restriction, is trapped by the Check Valve, by a closed Pneumatic Pressure Operated Relief Valve (PORV) [6], and by a closed Manual Emergency Release [7]. The trapped pressure holds the main valve's diaphragm and plug against the valve seat [8], sealing it drip-tight and keeping the system piping dry. The PORV is held closed by the pneumatic pressure maintained in the dry pilot line, supplied through the Solenoid [1]. Under FIRE condition, a dry pilot line pneumatic pressure drop, or an electric signal that triggers the Solenoid, opens the PORV. Pressure is then released from the main valve's control chamber to the downstream, through the Pressure Reducing (PR) Pilot [9] and the opened PORV. This allows the main valve to open, and water to flow into the system piping and to the alarm device. Should system pressure rise above PR pilot setting, the PR pilot throttles, thereby enabling pressure to accumulate in the valve control chamber. This causes the FP 400E-6DC to throttle closed, decreasing system pressure to PR pilot setting. The Manual Emergency Release [7], overrides the PR pilot, causing the valve to open fully.

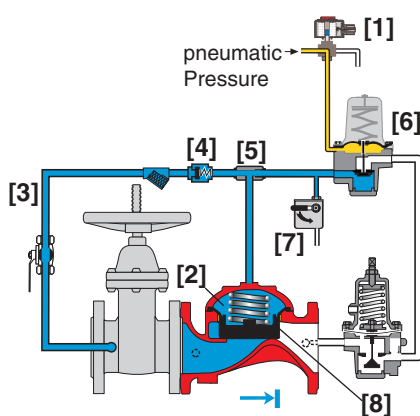

Valve Closed (set position)

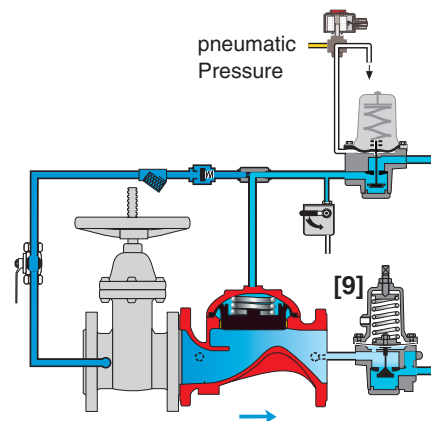

Valve Open (operating condition)

Engineer Specifications

- The On-Off deluge valve shall be a UL-Listed, electro-pneumatically remote controlled elastomeric type globe valve with a **rolling-diaphragm**.
- The valve shall have an **unobstructed flow path**, with no stem guide or **supporting ribs**.
- Valve actuation shall be accomplished by a fully peripherally supported, one-piece balanced rolling-diaphragm, vulcanized with a rugged radial seal disk. The diaphragm assembly shall be the only moving part.
- The valve shall have a removable cover for quick in-line service enabling all necessary inspection and servicing.
- The control trim materials shall consist of St.St. 316 tubing and fittings, and plated brass accessories, including Accelerator, PORV pneumatic pilot valve, 3-way Solenoid, 2-Way Pressure Reducing Pilot, Y strainer and Manual Emergency Release.
- The control trim shall be supplied as an assembly, pre-assembled and hydraulically tested at an ISO 9000 and 9001 certified factory.
- The Pressure Control and Electro-Pneumatically Remote Controlled, On-Off Deluge Valve shall open and close in response to activation of the solenoid and to dry line pneumatic pressure, reducing higher upstream pressure to pre-set lower downstream pressure.

BERMAD Fire Protection

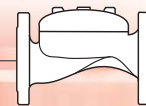

Model: FP 400E-6DC

400 Series

System Components

- 1 - Main Valve, BERMAD FP 400E Series
- 2B - Accelerator with Priming Restriction
- 2R - Pressure Reducing Pilot
- 4B - Priming Strainer
- 6B - Pneumatic Pressure Operated Relief Valve (PORV)
- 7B - Check Valve
- 15B - Manual Emergency Release
- 18B - Priming Valve
- 24B - 3-way Solenoid



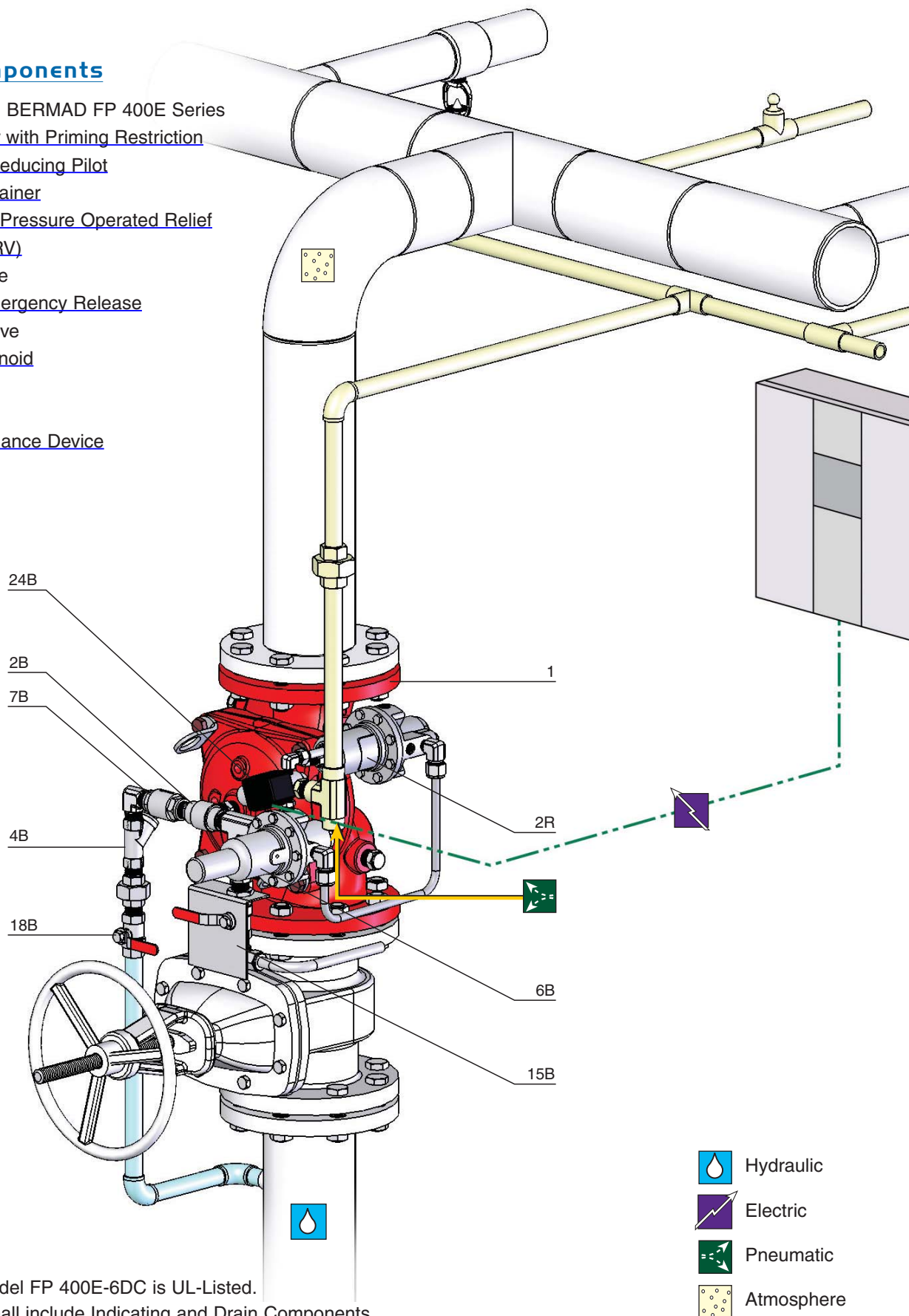

Optional

AMD - Air Maintenance Device



Note

The BERMAD Model FP 400E-6DC is UL-Listed.
The installation shall include Indicating and Drain Components.

-  Hydraulic
-  Electric
-  Pneumatic
-  Atmosphere

BERMAD Fire Protection

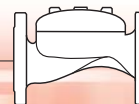

Model: FP 400E-6DC

400 Series

Technical Data

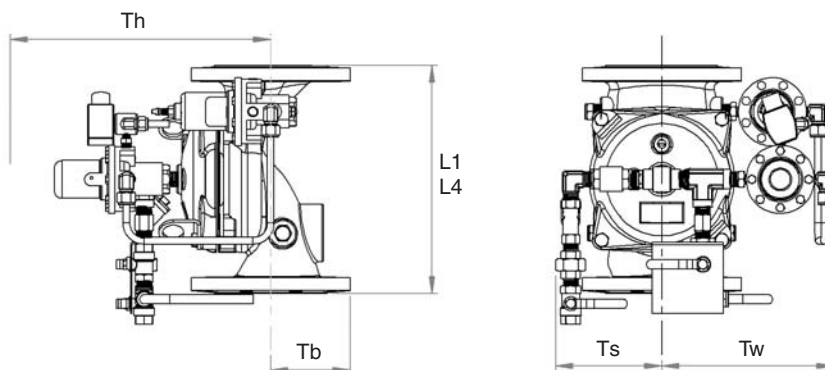

Valve Size	1 1/2", 2"		2 1/2"		3"		4"		6"		8"		10"		12"		
	mm	inch	mm	inch	mm	inch	mm	inch	mm	inch	mm	inch	mm	inch	mm	inch	
Dimensions	(1)L1	205	8 1/16	205	8 1/16	250	9 13/16	320	12 5/8	415	16 5/16	500	19 11/16	605	23 13/16	725	28 1/2
	(2)L4	205	8 1/16	N/A	N/A	250	9 13/16	320	12 5/8	N/A	N/A	N/A	N/A	N/A	N/A	N/A	N/A
	Ts	228	9	220	8 11/16	243	9 9/16	253	10	318	12 1/2	326	12 13/16	326	12 13/16	391	15 3/8
	Tw	318	12 1/2	329	12 15/16	340	13 13/16	352	13 13/16	393	15 1/2	423	16 5/8	443	17 7/16	481	18 15/16
	Th	255	10 1/16	263	10 3/8	272	10 11/16	282	11 1/8	315	12 7/16	332	13	330	13	368	14 1/2
	Tb	78	3 1/16	89	3 1/2	100	4	112	4 7/16	140	5 1/2	170	6 11/16	202	8	240	9 1/2

Notes:

- L1 is for flanged ANSI #150 and ISO PN16.
- L4 is for grooved end connections.
- Provide adequate space around valve for maintenance.
- Data is for envelope dimensions, specific component positioning may vary.

Connection Standard

- Flanged: ANSI B16.42 (Ductile Iron), B16.5 (Steel & Stainless Steel), B16.24 (Bronze) or ISO PN16
- Grooved: ANSI/AWWA C606 for 2, 3, 4 & 6"

Water Temperature

- 0.5 – 50°C (33 – 122°F)

Available Sizes

- 1 1/2", 2", 2 1/2", 3", 4", 6", 8", 10" & 12"
- UL-Listed for sizes 1 1/2", 2", 2 1/2", 3", 4", 6", & 8"

Pressure Rating*

- Max. inlet: 250 psi (17 bar)
- Set: 30-165 psi (4.5-11.5 bar)

* Pressure rating might be limited due to solenoid valve rating

Valve Outlet Pressure Fall-off Characteristics On Inlet Under Set Pressure

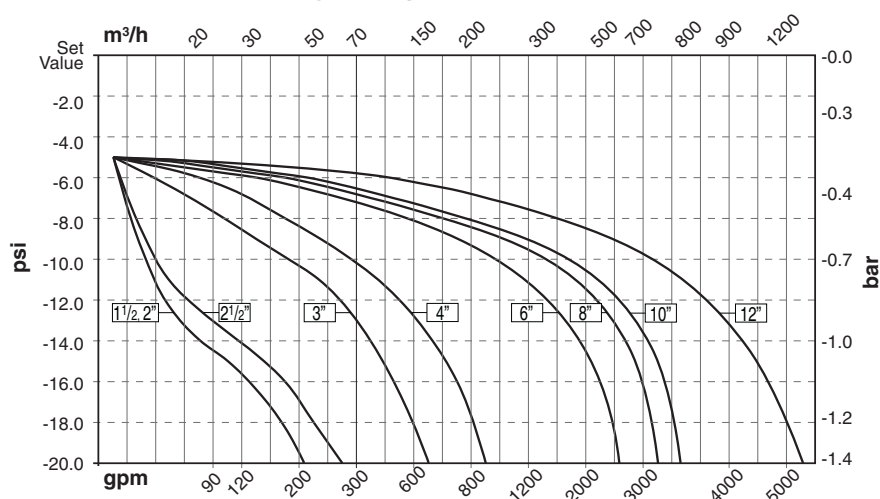

PORV Setting

- Valve opens on pilot line pressure drop
- Factory set: 20 psi (1.5 bar)

Manufacturers Standard Materials

Main valve body and cover

- Ductile Iron ASTM A-536

Main valve internals

- Stainless Steel 304 & Cast Iron

Control Trim System

- Brass control components/accessories
- Forged Brass Pressure Reducing Pilot with St. St. 304 Internals & NBR Elastomers
- Stainless Steel 316 tubing & fittings

Elastomers

- Nylon fabric reinforced polyisoprene NR

Coating

- Electrostatic Powder Coating Polyester, Red (RAL 3002)

Optional Materials

Main valve body

- Carbon Steel ASTM A-216 WCB
- Stainless SAteel 316
- Ni-Al-Bronze ASTM B-148

Control Trim

- Stainless Steel 316
- Monel® and Ni-Al-Bronze
- Hastalloy C-276

Elastomers

- NBR
- EPDM

Coating

- High Built Epoxy Fusion-Bonded with UV Protection, Anti-Corrosion

PORV set - opens on pressure drop

- Factory set: 20 psi (1.5 bar)

Solenoid Pilot Valve

Standard

- 3-way, direct actuated type
- Brass body
- Main valve closed when de-energized
- Enclosure: General purpose watertight, NEMA 4 and 4X / IP65, Class F
- Power: 24VDC, 8 watts
- UL - Listed

Options (see also ordering guide)

- Hazardous locations:
 - Class I Division 1, Gr. A, B, C, D, T4 (code 7)
 - Class I Division 2, Gr. A, B, C, D, T4
 - ATEX, EEx d IIC T5 (code 9)
- Voltage: see ordering guide (voltage option table)
- Stainless steel 316 body material (code K)



bermadfire@bermad.com • www.bermad.com

The information herein is subject to change without notice. BERMAD shall not be held liable for any errors. All rights reserved. © Copyright by BERMAD.

PE4PE-6DC 04