



COMBINATION AIR VALVE

Model MN-C70

BERMAD C70 is a high quality combination air valve for a variety of mining piping systems and operating conditions. It evacuates air during pipeline filling, allows efficient release of air pockets from pressurized pipes, and enables large volume air intake in the event of network draining.

With its advanced aerodynamic design, double orifice and Surge Protection (Anti-slam / slow closing) device, this valve provides excellent protection against air accumulation, vacuum formation and pressure surges, with improved sealing in low pressure conditions. The valve minimizes water spraying during air release.



Features & Benefits

- Straight flow body with nominal (equal) inlet and outlet size: Higher than usual flow rates.
- Aerodynamic, full-body kinetic shield: Prevents premature closing without disturbing air intake or discharge.
- Dynamic Sealing: Prevents leakage under low pressure conditions (1.5 psi; 0.1 bar).
- Minimizes fluid spraying during air release: Innovative 2-step function, automatic orifice (Patent Pending).
- Compact, simple and reliable structure with fully corrosion-resistant internal parts: Lower maintenance and increased life span.
- Designed in compliance with functional standards and water service standards.
- Factory approval and Quality Control: Performance and specification tested and measured with specialized test bench, including vacuum pressure conditions.

Additional Features & Accessories

- Built in Surge Protection C70-SP, C70-AC, C70-AS
- Anti-Slam feature for smoother operation, preventing damage to the valve and the system. C70-SP
- Adjustable "Switching Value" (pressure at which the kinetic orifice is partially closed) according to the specific system requirements. C70-AS
- Inflow Prevention: Prevents intake of atmospheric air in cases where this could lead to damaged pumps, required re-priming, or disruption of siphon. C50-IP
- Service Port fitted with 1/4", DN6 plug (codes P, U)
- Drainage Valve (code Z).
- Operational Data
- Minimum operating pressure: 1.5psi, 0.1bar
- Media & operating temperature: Water 33-140oF, 1-60oC
- Available outlet connections: 2"-3" female threaded, 4"-8" grooved

Pressure Rating

Class	PN16		PN25		PN40	
Max. Recommended Pressure	250 PSI		400 PSI		600 PSI	
Available Connection (inlet)	Flanged ANSI#150	Threaded NPT	Flanged ANSI#150	Threaded NPT	Flanged ANSI#150	Threaded NPT
Available Sizes (inlet)	2"-8"		2"-8"		2"-8"	

Materials

Main Components	Water/Base Solution Applications	Thermal Shock Applications	Acid Solutions Applications (*)
Body & Cover	Ductile Iron	Ductile Iron	Stainless Steel 316
Top Plate	Stainless Steel	Stainless Steel	Stainless Steel 316
Float Assembly	Polypropylene Glass Reinforced Nylon	Polypropylene Glass Reinforced Nylon	Polypropylene
Automatic Orifice	Stainless Steel	Stainless Steel	Stainless Steel 316
Elastomers	EPDM	EPDM	Viton
Coating	Fusion Bonded Epoxy	Fusion Bonded Epoxy	Uncoated

Typical Applications

- Pumping stations: air relief, vacuum prevention and surge protection.
- Pipelines: protection against air accumulation and vacuum formation at peaks and slope change points.
- Water hammer: protection against vacuum formation during down-surge stage in systems affected by water hammer phenomena.
- Suitable for almost all fluids used in mining such RAFF, ILS & PLS solutions for copper; cyanide barren and pregnant solutions for gold and seawater for desalination plants.



Orifice Specifications

Inlet Size		Automatic Orifice						Kinetic Orifice							
		250 psi PN16		400 psi PN25		600 psi PN40		Diameter		Area		Air Intake @ 6psi; -0.4 psi		Air Relief @ 6psi; -0.4 psi	
Inch	mm	Sq inch	Sq mm	Sq inch	Sq mm	Sq inch	Sq mm	inch	mm	Sq inch	Sq mm	ncfm	nm3/h	ncfm	nm3/h
2"	DN50	0.002	1.1	0.001	0.6	0.001	0.4	2.0	50	3.142	1,963	385	650	470	800
3"	DN80	0.004	2.5	0.002	1.5	0.002	1	3.0	80	7.069	5,027	1020	1730	1300	2200
4"	DN100	0.005	3.1	0.003	2	0.002	1.3	4.0	100	12.566	7,854	1560	2650	1890	3200
6"	DN150	0.014	9.1	0.009	5.7	0.005	3.5	6.0	150	28.724	17,671	3360	5700	4300	7300
8"	DN200	0.034	22.1	0.022	14.5	0.012	8	8.0	200	50.265	31,416	6650	11130	8710	14800

Air Flow Performance Charts - Standard Configuration

Air Relief and Intake (Pipeline Filling, Draining and Vacuum Conditions)

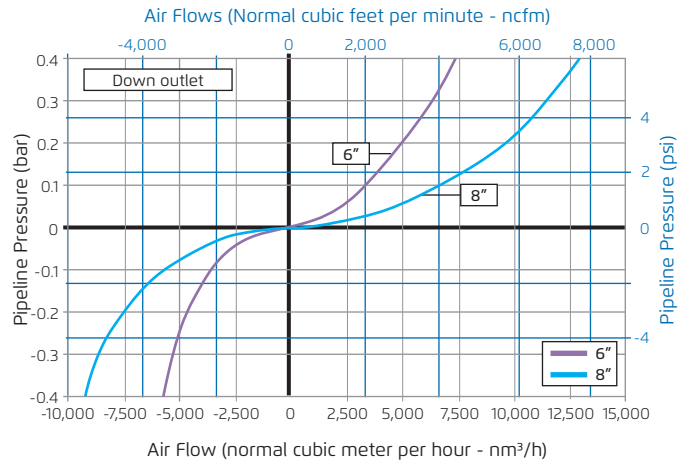
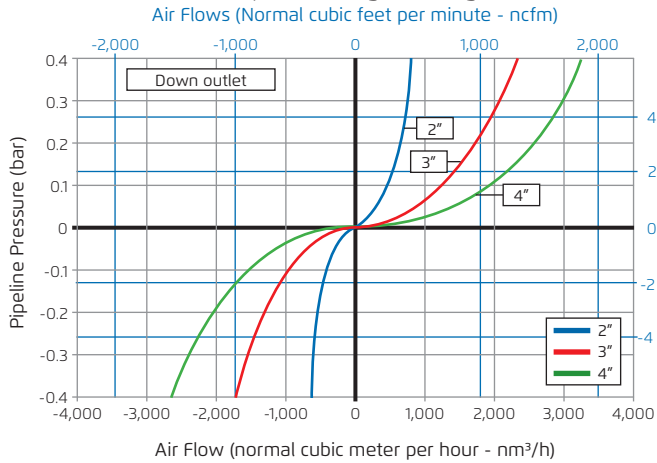

Air Release (Pressurized Operation)

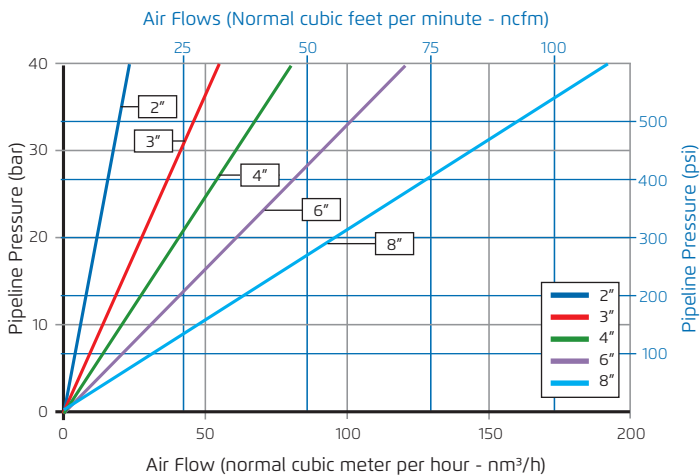



Data for Surge Protection Features

Inlet Size		Surge Protection					C70-SP Switching Value		C70-SP/AC/AS Air Relief @ 6psi ; 0.4bar	
		Number of holes	Hole Diameter		Total Area		psi	bar	ncfm	nm3/h
Inch	mm	---	inch	mm	Sq inch	Sq mm				
2"	DN50	4	0.197	5	0.122	79	0.57	0.04	200	350
3"	DN80	4	0.315	8	0.312	201	0.78	0.05	399	700
4"	DN100	4	0.394	10	0.487	314	0.71	0.05	627	1100
6"	DN150	4	0.591	15	1.096	707	0.64	0.04	958	1680
8"	DN200	4	0.787	20	1.947	1257	0.73	0.05	1471	2580

Air Relief with Surge Protection (Pipeline Filling)

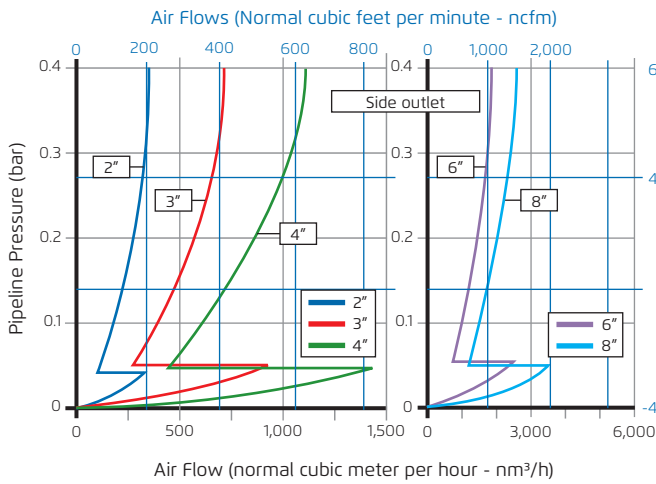

Air Relief with Inflow Prevention (Pipeline Filling)

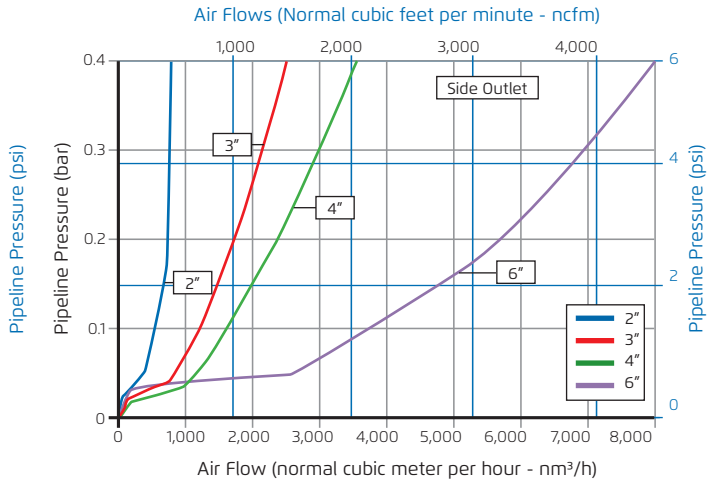

Dimensions & Weights

Inlet Size		Connection	Width (D)		Height (H)		Weight	
Inch	mm		inch	mm	inch	mm	lbs	Kg
2"	DN50	Threaded	7.126	181	11.181	284	17.2	7.8
2"	DN50	Flanged	7.362	187	11.890	302	22	10
3"	DN80	Flanged	9.646	245	14.016	356	37	16.8
4"	DN100	Flanged	11.142	283	16.142	410	49.1	22.3
6"	DN150	Flanged	14.488	368	22.480	571	110.2	50
8"	DN200	Flanged	18.701	475	30.315	770	266.7	121

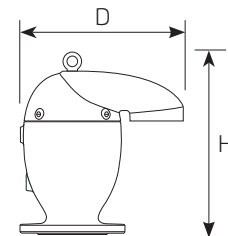

Note:
Shown data is for side outlet. For other outlet options consult factory.



Cutaway

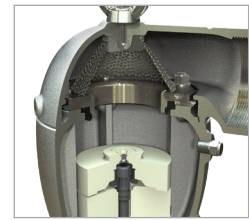
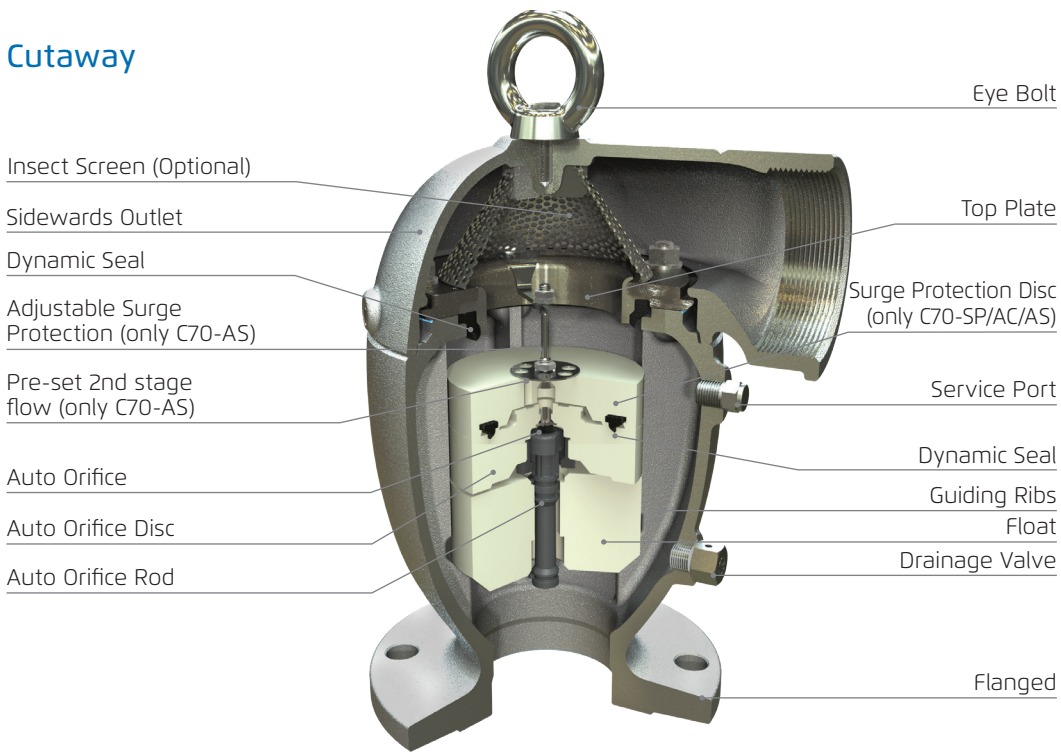

Without Surge Protection (C70)

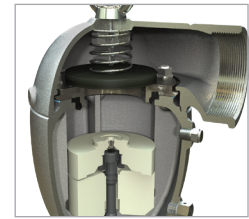

With Inflow Prevention (C70-IP)